

MA 840 Datasheet

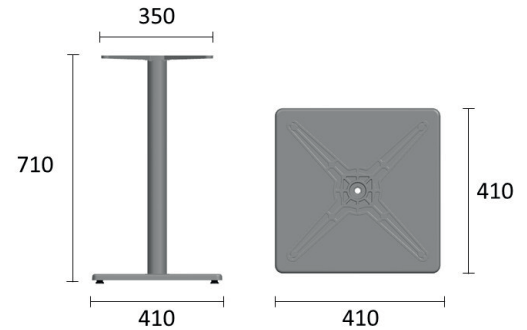

Table Bases



Logistic Information

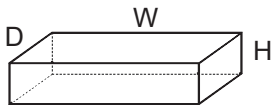

SKU/box	Width (cm)	Depth (cm)	Height (cm)	Net Weight (~ kg)	Gross Weight (~ kg)	CBM (m ³ /box)	20FT DC (SKU)	40FT DC (SKU)	TIR (SKU)
1 SKU/2 box	43,0	43,0	4,0	4,7	5,1	0,041	720	1.440	1.980
	73,0	7,0	6,5						

Material

- Column is Ø60 mm aluminum extrusion profile
- Base & cross are aluminum high pressure die casting

Recyclable product



Technical Information

- Outdoor and Indoor
- Corrosion resistance
- Easy to assemble
- Extra weight is optional (2,80 kg)
- Dimensional stability
- Shipped disassembled

Color Options



Coating

- Electrostatic powder coating
- Environmentally friendly surface treatment process provides high corrosion resistance
- Industrial product formulated especially for decoration and protection of metal components for both outdoor and indoor use. It offers good weathering resistance, good mechanical properties, and a good balance of coating properties.

Certifications

- The powder coating complies with the European Directives "Restriction of the use of certain hazardous substances" 2011/65/EU and 2015/863/EU (RoHS)
- Classification A2 (non flammable) of reaction to fire in accordance with NF EN 13501-1:2018

MH45216 (Fr)

Approvals
UL 1332



Maintenance

It is recommended to clean the products regularly especially in humid or marine climate locations to keep them in good condition for a long time. Clean the surfaces using a soft cloth with water or mild detergents. Prolonged and continuous exposure to intense UV radiation from sunlight or very low temperatures can negatively affect the coating therefore to keep products in sheltered places during non-use periods is strongly recommended.

Astor Aluminum

Barbaros Mah. Morsümbül Sk. No:5 D:305 Deluxia Palace
Ataşehir/ İSTANBUL

T: +90 (216) 510 4525

E-mail: info@astoral.com

<https://www.astoral.com>